

Profil LED / Profile LED

PERO

Karta produktu Data sheet

PL
Profile międzyplytowe, konstrukcyjne – do stosowania w sufitach podwieszanych w budownictwie mieszkaniowym.

EN
Recessed drywall system profiles – to be used in suspended ceilings in residential construction.

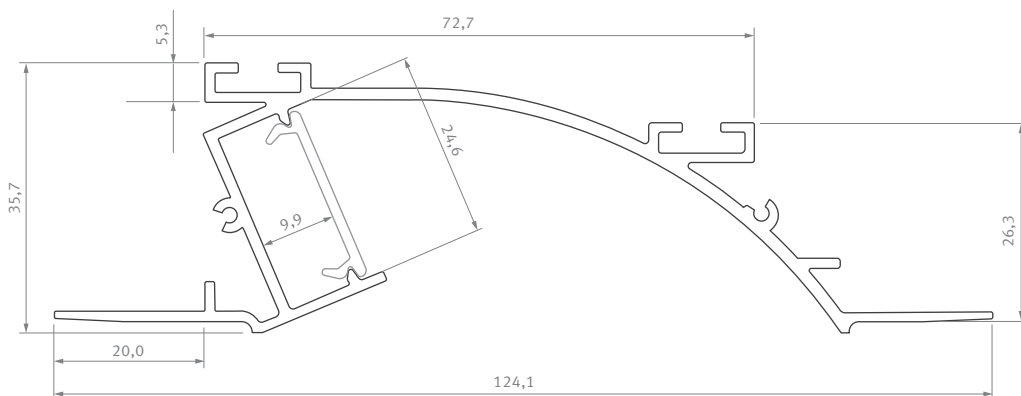

Sposoby montażu /
Assembly methods



Obejrzyj wideo /
Watch video



PERO

Profil LED / Profile LED

Wymiary [mm] / Dimensions [mm]: 1000, 2020, 3000

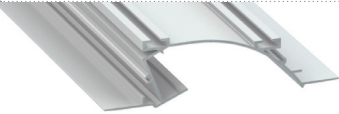
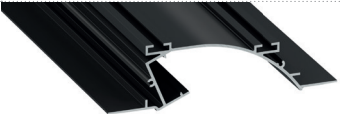
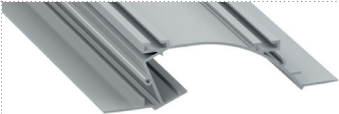





	BIAŁY (lakierowany) white (lacquered)	CZARNY (lakierowany) black (lacquered)	SREBRNY (anodowany) silver (anodized)
PERO			
1,0 m	10-0511-10	10-0475-10	10-0514-10
2,02 m	10-0511-20	10-0615-20	10-0514-20
3,0 m	10-0511-30	10-0475-30	10-0514-30
Szerokość taśmy LED [mm] LED strip width [mm]	do 12 up to 12		

Klosze (PMMA) / Covers

Wymiary [mm] / Dimensions [mm]: 1000, 2020, 3000

TRANSPARENTNY transparent	MROŻONY frozen	MLECZNY milky	FROSTED MLECZNY milky frosted	CZARNY PMMA black PMMA
DOUBLE				
				
1 m/PMMA 11-2073-10	1 m/PMMA 11-2072-10	1 m/PMMA 11-2071-10	1 m/PMMA 11-2076-10	1 m/PMMA 11-2447-10

Zasłepki (aluminium) / End caps (aluminum)

Z OTWOREM with a hole					
BIAŁY white	CZARNY black	PERO		SREBRNY silver	
LEWA left	PRAWA right	LEWA left	PRAWA right	LEWA left	PRAWA right
					
ALU 12-0551-10	ALU 12-0561-10	ALU 12-0552-10	ALU 12-0562-10	ALU 12-0555-10	ALU 12-0565-10

Dodatki / Accessories

ŁĄCZNIK PROSTY straight connector	ŁĄCZNIK POPRZECZNY KĄTOWY angular transverse connector	ŁĄCZNIK KĄTOWY 90° angular connector 90°	ŁĄCZNIK KĄTOWY 120° angular connector 120°	SPRĘŻYNY MONTAŻOWE mounting springs
				
14-3032-02	14-3038-01	14-3030-01	14-3036-01	14-5001-00

Maksymalna rozpraszana moc źródeł światła LED

Maximum dissipated power of LED light sources

dla temperatury profilu for temperature profile 55° C	dla temperatury profilu for temperature profile 65° C
81,2 W	102,2 W

LUMINES[®]
LIGHTING

www.lumines.pl

